

LM2902, LM324/LM324A, LM224/ LM224A

Quad Operational Amplifier

Features

- Internally Frequency Compensated for Unity Gain
- Large DC Voltage Gain: 100dB
- Wide Power Supply Range:
LM224/LM224A, LM324/LM324A : 3V~32V (or $\pm 1.5 \sim 15V$)
LM2902: 3V~26V (or $\pm 1.5V \sim 13V$)
- Input Common Mode Voltage Range Includes Ground
- Large Output Voltage Swing: 0V to $V_{CC} - 1.5V$
- Power Drain Suitable for Battery Operation

Description

The LM324/LM324A, LM2902, LM224/LM224A consist of four independent, high gain, internally frequency compensated operational amplifiers which were designed specifically to operate from a single power supply over a wide voltage range. Operation from split power supplies is also possible so long as the difference between the two supplies is 3 volts to 32 volts. Application areas include transducer amplifier, DC gain blocks and all the conventional OP-AMP circuits which now can be easily implemented in single power supply systems.



Internal Block Diagram

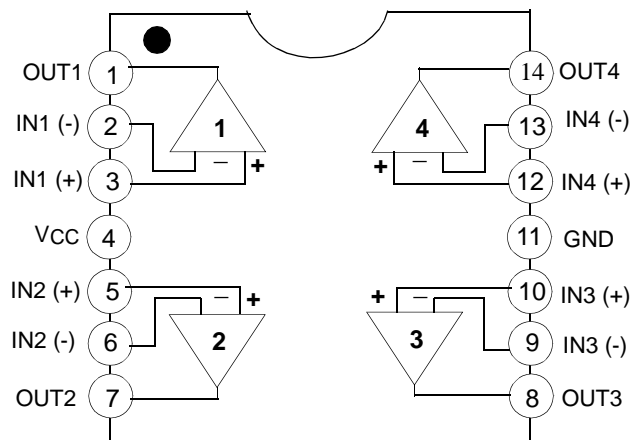

Schematic Diagram

(One Section Only)

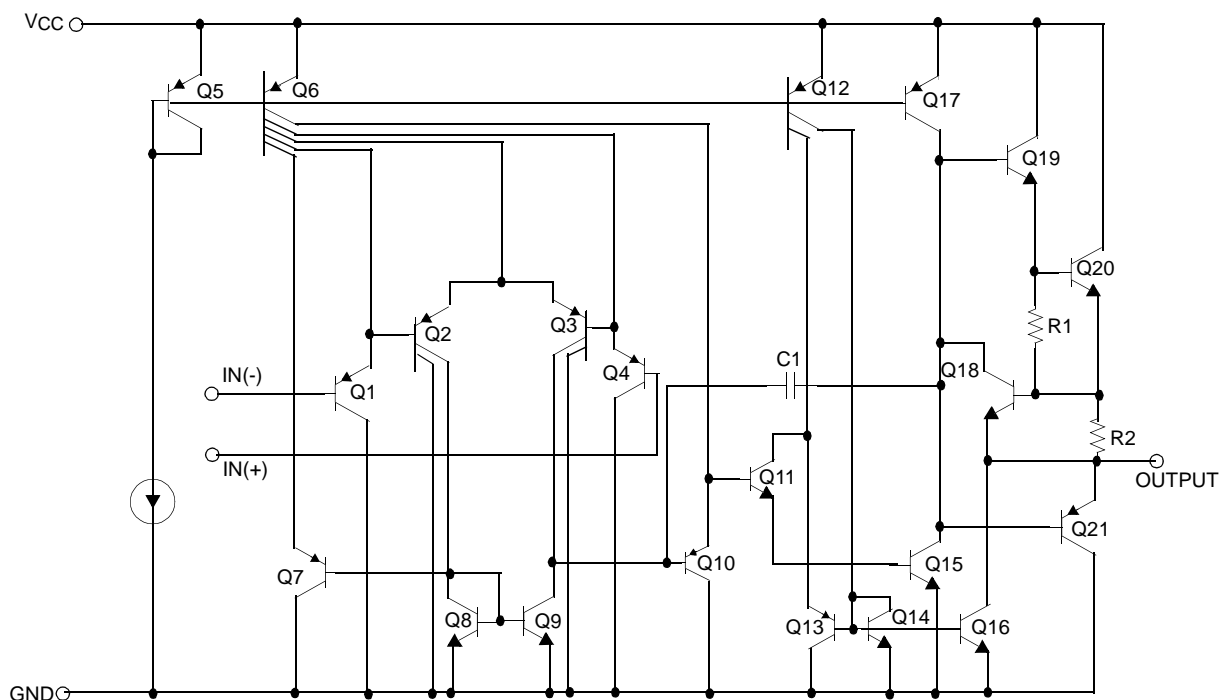

Absolute Maximum Ratings

| Parameter | Symbol | LM224/LM224A | LM324/LM324A | LM2902 | Unit |
|--|----------|--------------|--------------|-------------|------|
| Power Supply Voltage | VCC | ±16 or 32 | ±16 or 32 | ±13 or 26 | V |
| Differential Input Voltage | VI(DIFF) | 32 | 32 | 26 | V |
| Input Voltage | VI | -0.3 to +32 | -0.3 to +32 | -0.3 to +26 | V |
| Output Short Circuit to GND Vcc≤15V, TA=25°C(one Amp) | - | Continuous | Continuous | Continuous | - |
| Power Dissipation, TA=25°C 14-DIP 14-SOP | PD | 1310 640 | 1310 640 | 1310 640 | mW |
| Operating Temperature Range | TOPR | -25 ~ +85 | 0 ~ +70 | -40 ~ +85 | °C |
| Storage Temperature Range | TSTG | -65 ~ +150 | -65 ~ +150 | -65 ~ +150 | °C |

Thermal Data

| Parameter | Symbol | Value | Unit |
|--|--------|-----------|------|
| Thermal Resistance Junction-Ambient Max. 14-DIP 14-SOP | Rθja | 95 195 | °C/W |

Electrical Characteristics

($V_{CC} = 5.0V$, $V_{EE} = GND$, $T_A = 25^\circ C$, unless otherwise specified)

| Parameter | Symbol | Conditions | LM224 | | | LM324 | | | LM2902 | | | Unit | |
|---------------------------------|---------------|--|-------------------|------|----------------|-------|----------------|----------|--------|------|----------------|----------|---|
| | | | Min. | Typ. | Max. | Min. | Typ. | Max. | Min. | Typ. | Max. | | |
| Input Offset Voltage | V_{IO} | $V_{CM} = 0V$ to $V_{CC} - 1.5V$ $V_{O(P)} = 1.4V$, $R_S = 0\Omega$ | - | 1.5 | 5.0 | - | 1.5 | 7.0 | - | 1.5 | 7.0 | mV | |
| Input Offset Current | I_{IO} | - | - | 2.0 | 30 | - | 3.0 | 50 | - | 3.0 | 50 | nA | |
| Input Bias Current | I_{BIAS} | - | - | 40 | 150 | - | 40 | 250 | - | 40 | 250 | nA | |
| Common-Mode Input Voltage Range | $V_{I(R)}$ | Note1 | 0 | - | $V_{CC} - 1.5$ | 0 | $V_{CC} - 1.5$ | - | 0 | - | $V_{CC} - 1.5$ | V | |
| Supply Current | I_{CC} | $R_L = \infty$, $V_{CC} = 30V$ (all Amps) | - | 1.0 | 3 | - | 1.0 | 3 | - | 1.0 | 3 | mA | |
| | | $R_L = \infty$, $V_{CC} = 5V$ (all Amps) ($V_{CC} = 26V$ for LM2902) | - | 0.7 | 1.2 | - | 0.7 | 1.2 | - | 0.7 | 1.2 | mA | |
| Large Signal Voltage Gain | G_V | $V_{CC} = 15V$, $R_L \geq 2K\Omega$ $V_{O(P)} = 1V$ to $11V$ | 50 | 100 | - | 25 | 100 | - | - | 100 | - | V/ mV | |
| Output Voltage Swing | $V_{O(H)}$ | Note1 | $R_L = 2K\Omega$ | 26 | - | - | 26 | - | - | 22 | - | - | V |
| | | | $R_L = 10K\Omega$ | 27 | 28 | - | 27 | 28 | - | 23 | 24 | - | V |
| | $V_{O(L)}$ | $V_{CC} = 5V$, $R_L \geq 10K\Omega$ | - | 5 | 20 | - | 5 | 20 | - | 5 | 100 | mV | |
| Common-Mode Rejection Ratio | CMRR | - | 70 | 85 | - | 65 | 75 | - | 50 | 75 | - | dB | |
| Power Supply Rejection Ratio | PSRR | - | 65 | 100 | - | 65 | 100 | - | 50 | 100 | - | dB | |
| Channel Separation | CS | $f = 1KHz$ to $20KHz$ | - | 120 | - | - | 120 | - | - | 120 | - | dB | |
| Short Circuit to GND | I_{SC} | - | - | 40 | 60 | - | 40 | 60 | - | 40 | 60 | mA | |
| Output Current | I_{SOURCE} | $V_{I(+)} = 1V$, $V_{I(-)} = 0V$ $V_{CC} = 15V$, $V_{O(P)} = 2V$ | 20 | 40 | - | 20 | 40 | - | 20 | 40 | - | mA | |
| | I_{SINK} | $V_{I(+)} = 0V$, $V_{I(-)} = 1V$ $V_{CC} = 15V$, $V_{O(P)} = 2V$ | 10 | 13 | - | 10 | 13 | - | 10 | 13 | - | mA | |
| | | $V_{I(+)} = 0V$, $V_{I(-)} = 1V$ $V_{CC} = 15V$, $V_{O(R)} = 200mV$ | 12 | 45 | - | 12 | 45 | - | - | - | - | μA | |
| Differential Input Voltage | $V_{I(DIFF)}$ | - | - | - | V_{CC} | - | - | V_{CC} | - | - | V_{CC} | V | |

Note :

1. $V_{CC} = 30V$ for LM224 and LM324, $V_{CC} = 26V$ for LM2902

Electrical Characteristics (Continued)

(VCC = 5.0V, VEE = GND, unless otherwise specified)

The following specifications apply over the range of $-25^{\circ}\text{C} \leq T_A \leq +85^{\circ}\text{C}$ for the LM224; and the $0^{\circ}\text{C} \leq T_A \leq +70^{\circ}\text{C}$ for the LM324; and the $-40^{\circ}\text{C} \leq T_A \leq +85^{\circ}\text{C}$ for the LM2902

| Parameter | Symbol | Conditions | LM224 | | | LM324 | | | LM2902 | | | Unit | |
|---------------------------------|--------------------------|---|--------------------------|------|----------------|-------|------|----------------|--------|------|----------------|--------------------------------|---|
| | | | Min. | Typ. | Max. | Min. | Typ. | Max. | Min. | Typ. | Max. | | |
| Input Offset Voltage | V_{IO} | $V_{ICM} = 0\text{V to } V_{CC} - 1.5\text{V}$ $V_{O(P)} = 1.4\text{V}$, $R_S = 0\Omega$ | - | - | 7.0 | - | - | 9.0 | - | - | 10.0 | mV | |
| Input Offset Voltage Drift | $\Delta V_{IO}/\Delta T$ | - | - | 7.0 | - | - | 7.0 | - | - | 7.0 | - | $\mu\text{V}/^{\circ}\text{C}$ | |
| Input Offset Current | I_{IO} | - | - | - | 100 | - | - | 150 | - | - | 200 | nA | |
| Input Offset Current Drift | $\Delta I_{IO}/\Delta T$ | - | - | 10 | - | - | 10 | - | - | 10 | - | $\text{pA}/^{\circ}\text{C}$ | |
| Input Bias Current | I_{BIAS} | - | - | - | 300 | - | - | 500 | - | - | 500 | nA | |
| Common-Mode Input Voltage Range | $V_{I(R)}$ | Note1 | 0 | - | $V_{CC} - 2.0$ | 0 | - | $V_{CC} - 2.0$ | 0 | - | $V_{CC} - 2.0$ | V | |
| Large Signal Voltage Gain | G_V | $V_{CC} = 15\text{V}$, $R_L \geq 2.0\text{K}\Omega$ $V_{O(P)} = 1\text{V to } 11\text{V}$ | 25 | - | - | 15 | - | - | 15 | - | - | V/mV | |
| Output Voltage Swing | $V_{O(H)}$ | Note1 | $R_L = 2\text{K}\Omega$ | 26 | - | - | 26 | - | - | 22 | - | - | V |
| | | | $R_L = 10\text{K}\Omega$ | 27 | 28 | - | 27 | 28 | - | 23 | 24 | - | V |
| | $V_{O(L)}$ | $V_{CC} = 5\text{V}$, $R_L \geq 10\text{K}\Omega$ | - | 5 | 20 | - | 5 | 20 | - | 5 | 100 | mV | |
| Output Current | I_{SOURCE} | $V_{I(+)} = 1\text{V}$, $V_{I(-)} = 0\text{V}$ $V_{CC} = 15\text{V}$, $V_{O(P)} = 2\text{V}$ | 10 | 20 | - | 10 | 20 | - | 10 | 20 | - | mA | |
| | I_{SINK} | $V_{I(+)} = 0\text{V}$, $V_{I(-)} = 1\text{V}$ $V_{CC} = 15\text{V}$, $V_{O(P)} = 2\text{V}$ | 10 | 13 | - | 5 | 8 | - | 5 | 8 | - | mA | |
| Differential Input Voltage | $V_{I(DIFF)}$ | - | - | - | V_{CC} | - | - | V_{CC} | - | - | V_{CC} | V | |

Note:1. $V_{CC} = 30\text{V}$ for LM224 and LM324, $V_{CC} = 26\text{V}$ for LM2902

Electrical Characteristics (Continued)

(VCC = 5.0V, VEE = GND, TA = 25°C, unless otherwise specified)

| Parameter | Symbol | Conditions | LM224A | | | LM324A | | | Unit | |
|---------------------------------|----------------------|--|------------------------|------|-------------------------|--------|------|-------------------------|------|----|
| | | | Min. | Typ. | Max. | Min. | Typ. | Max. | | |
| Input Offset Voltage | V _{IO} | V _{CM} = 0V to V _{CC} -1.5V V _{O(P)} = 1.4V, R _S = 0 Ω | - | 1.0 | 3.0 | - | 1.5 | 3.0 | mV | |
| Input Offset Current | I _{IO} | - | - | 2 | 15 | - | 3.0 | 30 | nA | |
| Input Bias Current | I _{BIAS} | - | - | 40 | 80 | - | 40 | 100 | nA | |
| Input Common-Mode Voltage Range | V _{I(R)} | V _{CC} = 30V | 0 | - | V _{CC} -1.5 | 0 | - | V _{CC} -1.5 | V | |
| Supply Current (All Amps) | I _{CC} | V _{CC} = 30V | - | 1.5 | 3 | - | 1.5 | 3 | mA | |
| | | V _{CC} = 5V | - | 0.7 | 1.2 | - | 0.7 | 1.2 | mA | |
| Large Signal Voltage Gain | G _V | V _{CC} = 15V, R _L ≥ 2 KΩ V _{O(P)} = 1V to 11V | 50 | 100 | - | 25 | 100 | - | V/mV | |
| Output Voltage Swing | V _{O(H)} | Note1 | R _L = 2 KΩ | 26 | - | - | 26 | - | - | V |
| | | | R _L = 10 KΩ | 27 | 28 | - | 27 | 28 | - | V |
| | V _{O(L)} | V _{CC} = 5V, R _L ≥ 10 KΩ | | - | 5 | 20 | - | 5 | 20 | mV |
| Common-Mode Rejection Ratio | CMRR | - | 70 | 85 | - | 65 | 85 | - | dB | |
| Power Supply Rejection Ratio | PSRR | - | 65 | 100 | - | 65 | 100 | - | dB | |
| Channel Separation | CS | f = 1KHz to 20KHz | - | 120 | - | - | 120 | - | dB | |
| Short Circuit to GND | I _{SC} | - | - | 40 | 60 | - | 40 | 60 | mA | |
| Output Current | I _{SOURCE} | V _{I(+)} = 1V, V _{I(-)} = 0V V _{CC} = 15V | 20 | 40 | - | 20 | 40 | - | mA | |
| | I _{SINK} | V _{I(+)} = 0V, V _{I(-)} = 1V V _{CC} = 15V, V _{O(P)} = 2V | 10 | 20 | - | 10 | 20 | - | mA | |
| | | V _{I(+)} = 0V, V _{I(-)} = 1V V _{CC} = 15V, V _{O(P)} = 200mV | 12 | 50 | - | 12 | 50 | - | μA | |
| Differential Input Voltage | V _{I(DIFF)} | - | - | - | V _{CC} | - | - | V _{CC} | V | |

Note:1. V_{CC}=30V for LM224A, LM324A

Electrical Characteristics (Continued)

(VCC = 5.0V, VEE = GND, unless otherwise specified)

The following specification apply over the range of $-25^{\circ}\text{C} \leq T_A \leq +85^{\circ}\text{C}$ for the LM224A; and the $0^{\circ}\text{C} \leq T_A \leq +70^{\circ}\text{C}$ for the LM324A

| Parameter | Symbol | Conditions | LM224A | | | LM324A | | | Unit | |
|---------------------------------|----------------------|--|-----------------------|------|----------------------|--------|------|----------------------|-------|---|
| | | | Min. | Typ. | Max. | Min. | Typ. | Max. | | |
| Input Offset Voltage | V _{IO} | V _{CM} = 0V to V _{CC} -1.5V V _{O(P)} = 1.4V, R _S = 0Ω | - | - | 4.0 | - | - | 5.0 | mV | |
| Input Offset Voltage Drift | ΔV _{IO} /ΔT | - | - | 7.0 | 20 | - | 7.0 | 30 | μV/°C | |
| Input Offset Current | I _{IO} | - | - | - | 30 | - | - | 75 | nA | |
| Input Offset Current Drift | ΔI _{IO} /ΔT | - | - | 10 | 200 | - | 10 | 300 | pA/°C | |
| Input Bias Current | I _{BIAS} | - | - | 40 | 100 | - | 40 | 200 | nA | |
| Common-Mode Input Voltage Range | V _{I(R)} | V _{CC} = 30V | 0 | - | V _{CC} -2.0 | 0 | - | V _{CC} -2.0 | V | |
| Large Signal Voltage Gain | G _V | V _{CC} = 15V, R _L ≥ 2.0KΩ | 25 | - | - | 15 | - | - | V/mV | |
| Output Voltage Swing | V _{O(H)} | V _{CC} = 30V | R _L = 2KΩ | 26 | - | - | 26 | - | - | V |
| | | | R _L = 10KΩ | 27 | 28 | - | 27 | 28 | - | |
| | V _{O(L)} | V _{CC} = 5V, R _L ≥ 10KΩ | - | 5 | 20 | - | 5 | 20 | mV | |
| Output Current | I _{SOURCE} | V _{I(+)} = 1V, V _{I(-)} = 0V V _{CC} = 15V | 10 | 20 | - | 10 | 20 | - | mA | |
| | I _{SINK} | V _{I(+)} = 0V, V _{I(-)} = 1V V _{CC} = 15V | 5 | 8 | - | 5 | 8 | - | mA | |
| Differential Input Voltage | V _{I(DIFF)} | - | - | - | V _{CC} | - | - | V _{CC} | V | |

Typical Performance Characteristics

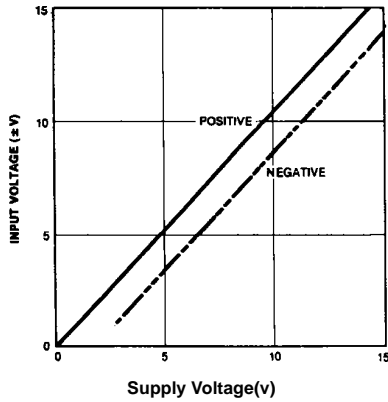

Figure 1. Input Voltage Range vs Supply Voltage

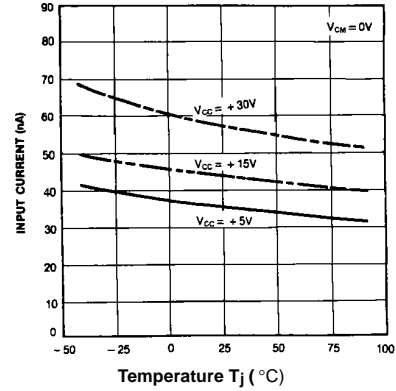

Figure 2. Input Current vs Temperature

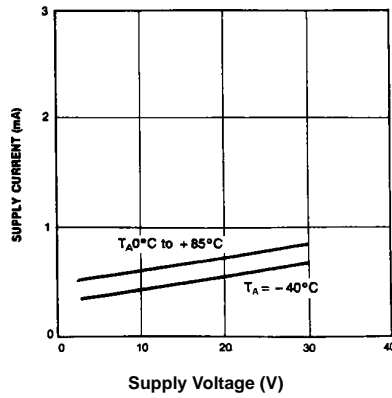

Figure 3. Supply Current vs Supply Voltage

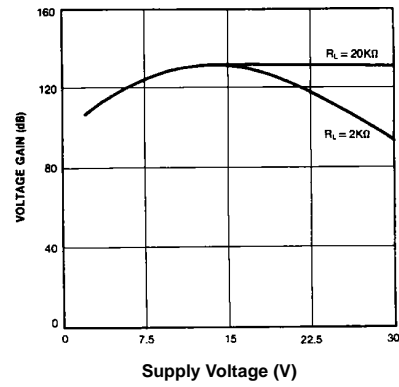

Figure 4. Voltage Gain vs Supply Voltage

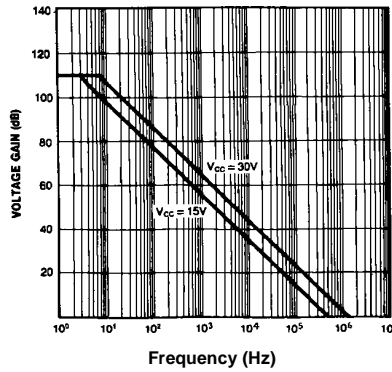

Figure 5. Open Loop Frequency Response

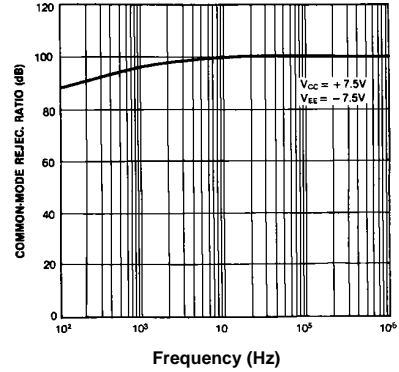

Figure 6. Common mode Rejection Ratio

Typical Performance Characteristics (Continued)

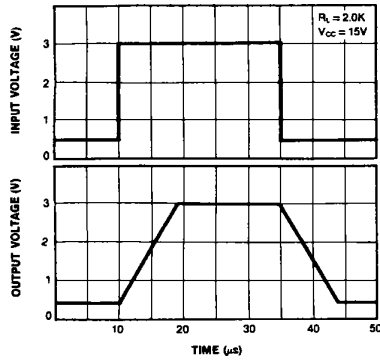

Figure 7. Slew Rate

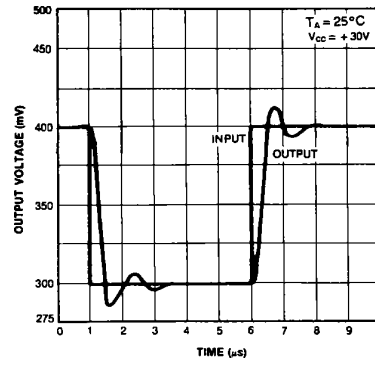

Figure 8. Voltage Follower Pulse Response

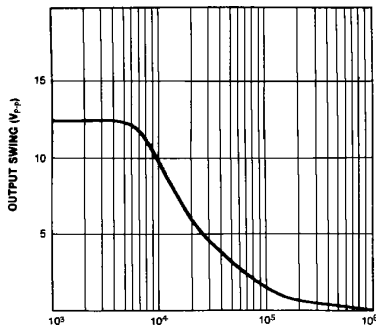

Figure 9. Large Signal Frequency Response

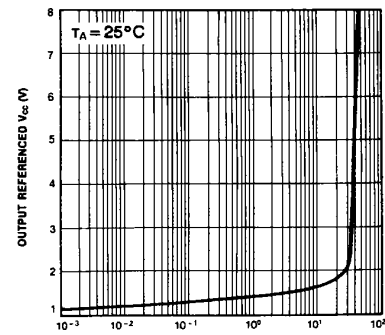

Figure 10. Output Characteristics vs Current Sourcing

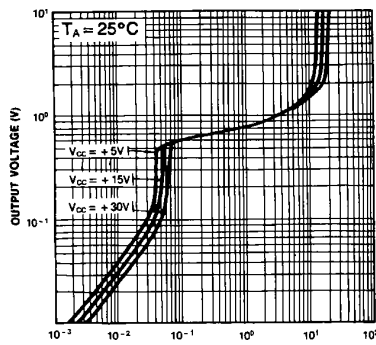

Figure 11. Output Characteristics vs Current Sinking

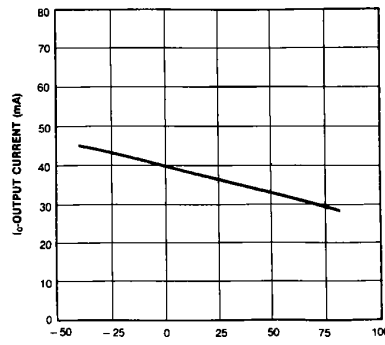

Figure 12. Current Limiting vs Temperature

Mechanical Dimensions

Package

Dimensions in millimeters

14-DIP

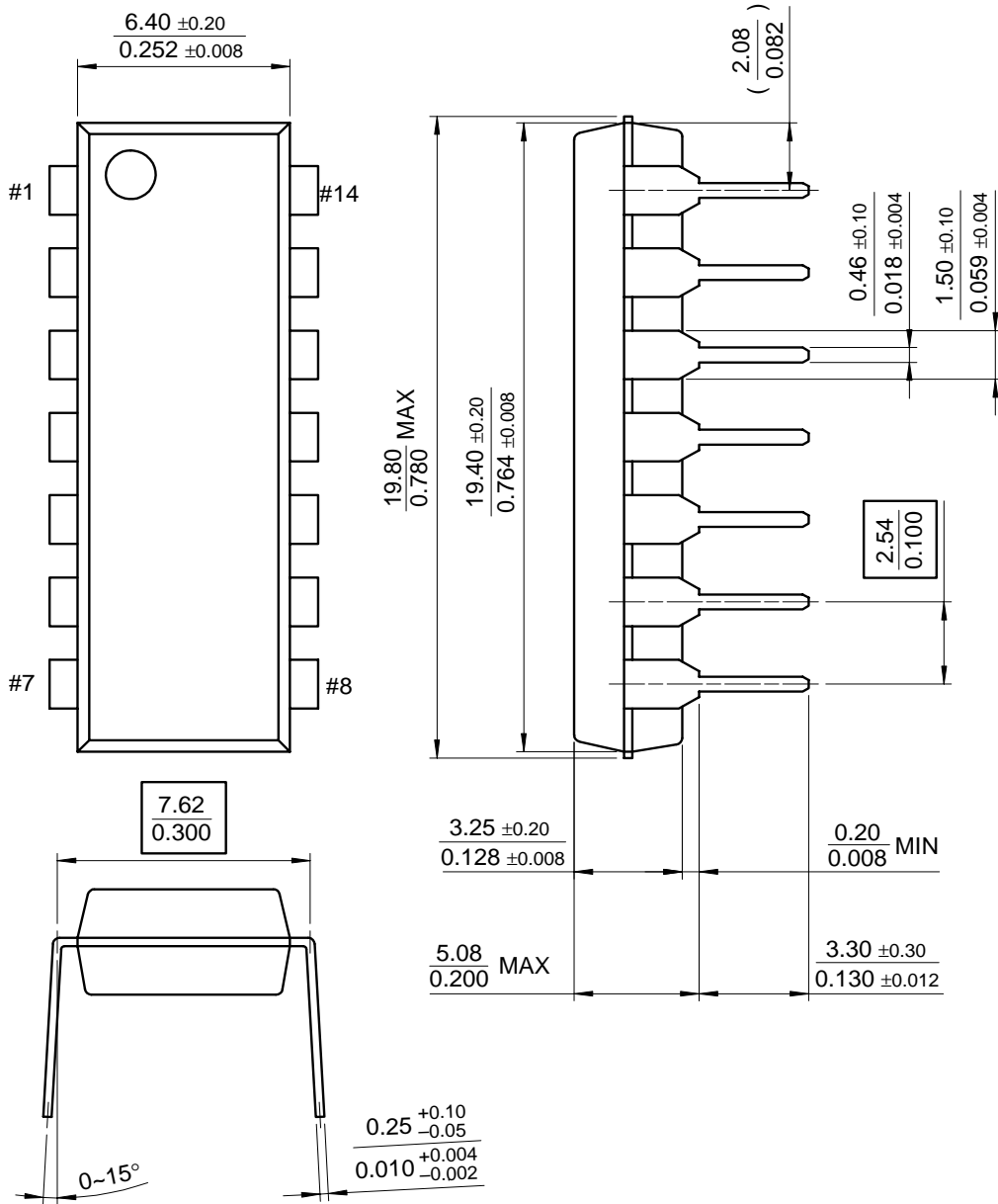

Mechanical Dimensions (Continued)

Package

Dimensions in millimeters

14-SOP

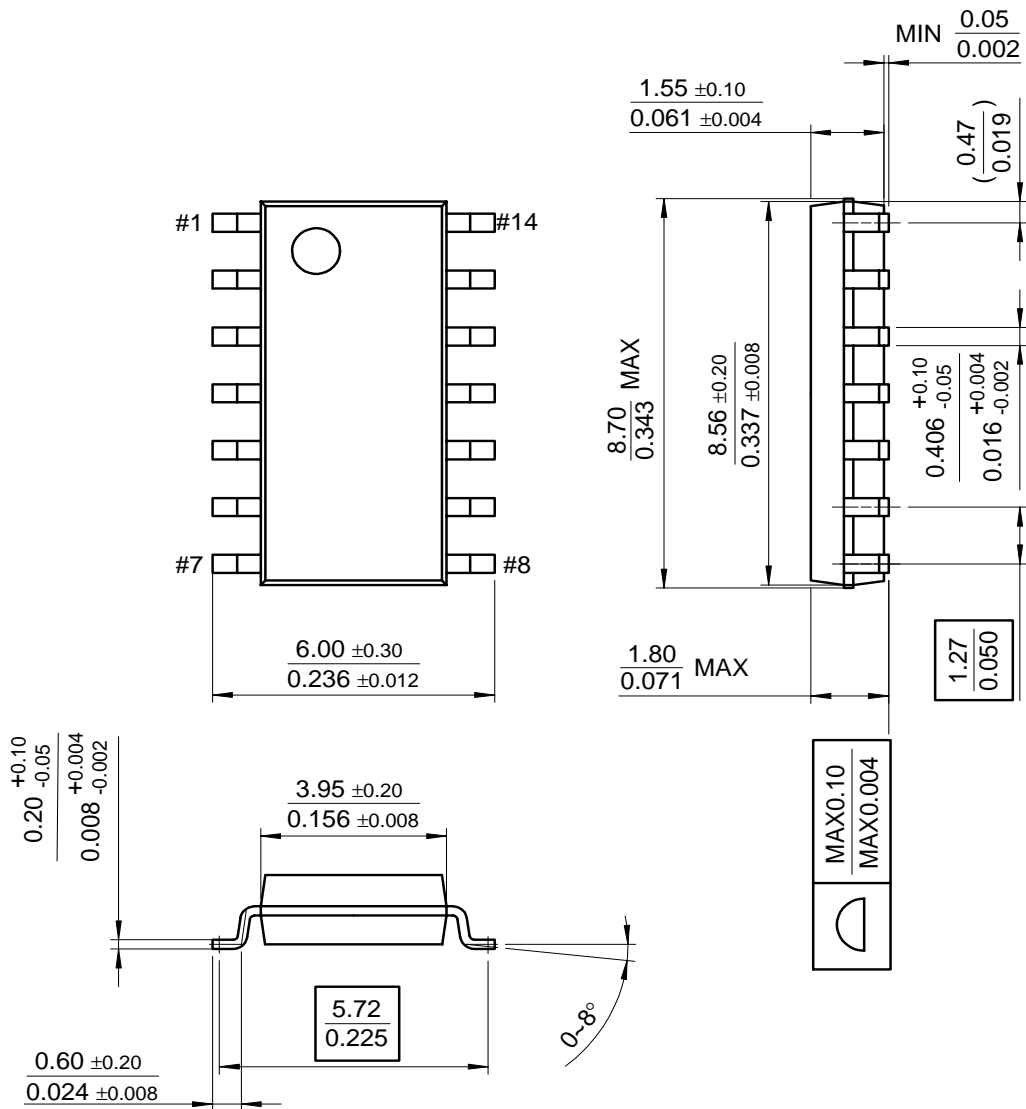

Ordering Information

| Product Number | Package | Operating Temperature |
|----------------|---------|-----------------------|
| LM324N | 14-DIP | 0 ~ +70°C |
| LM324AN | | |
| LM324M | 14-SOP | |
| LM324AM | | |
| LM2902N | 14-DIP | -40 ~ +85°C |
| LM2902M | 14-SOP | |
| LM224N | 14-DIP | -25 ~ +85°C |
| LM224AN | | |
| LM224M | 14-SOP | |
| LM224AM | | |

DISCLAIMER

FAIRCHILD SEMICONDUCTOR RESERVES THE RIGHT TO MAKE CHANGES WITHOUT FURTHER NOTICE TO ANY PRODUCTS HEREIN TO IMPROVE RELIABILITY, FUNCTION OR DESIGN. FAIRCHILD DOES NOT ASSUME ANY LIABILITY ARISING OUT OF THE APPLICATION OR USE OF ANY PRODUCT OR CIRCUIT DESCRIBED HEREIN; NEITHER DOES IT CONVEY ANY LICENSE UNDER ITS PATENT RIGHTS, NOR THE RIGHTS OF OTHERS.

LIFE SUPPORT POLICY

FAIRCHILD'S PRODUCTS ARE NOT AUTHORIZED FOR USE AS CRITICAL COMPONENTS IN LIFE SUPPORT DEVICES OR SYSTEMS WITHOUT THE EXPRESS WRITTEN APPROVAL OF THE PRESIDENT OF FAIRCHILD SEMICONDUCTOR CORPORATION. As used herein:

1. Life support devices or systems are devices or systems which, (a) are intended for surgical implant into the body, or (b) support or sustain life, and (c) whose failure to perform when properly used in accordance with instructions for use provided in the labeling, can be reasonably expected to result in a significant injury of the user.
2. A critical component in any component of a life support device or system whose failure to perform can be reasonably expected to cause the failure of the life support device or system, or to affect its safety or effectiveness.